

ROOFING *Accessories*



2017 Beloit Plant
PRODUCT CATALOG

www.acm-metals.com

2017 Beloit Plant
**ROOFING ACCESSORIES
CATALOG**

Table of Contents

Angle Flashing	2	Reglet Flashing	8
Colorado Drip Edge	3	Counter Flashing	8
C-Channel	3	Chimney Flashing	8
Drip Edge	4-5	Flashing Sheet	9
Professional (Closed Face)	4	Flat Shingle	9
Standard (Closed Face)	4	Pre-Bent Step Flashing	10-11
Professional (Open Face)	5	Roll Valley	12
F-8 Large (Open Face).....	5	Roof to Wall Flashing	13
26 Gauge Galvanized (Open Face)	5	Side Wall Flashing	14
Rake Edge 90°	6	Tile Pan Flashing	14
Professional	6	W-Valley & W-Valley Professional	15
Professional 2-3/4" Back Crown Face.....	6	ACM Stone Coat Ventilation	16
Standard	6	Z Flashing	17
26 Gauge	6	Drip Cap	18
Gravel Stop	7		
Gutter Apron 25°	7		
Rain Diverter	8		

All ACM products are painted with Valspar's Diamond Flex™ paint system.



We reserve the right to change the content of product offerings at any time. Please consult the online catalog at www.acm-metals.com for the most update product offering.

Contact Information:

CUSTOMER SERVICE: 877-279-5096
www.acm-metals.com



Angle Flashing

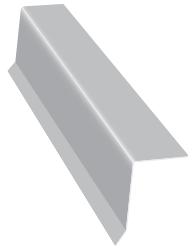

Part #	Description	Colors	Nom. Gauge/ Thickness	Piece Length	Pieces/ Box	Boxes/ Pallet	Pieces/ Pallet
Standard							
AAF2210 - -	Aluminum 2 x 2 (C4)	RB/WH	0.019	10'	25	35	875
AAF32531WH	Aluminum 2-5/8 x 3	WH	0.032	10'	25	35	875
AAF22210WH	Aluminum 2 x 2	WH	0.024	10'	10	35	350
AAF3310 - -	Aluminum 3 x 3 (C5-1/2)	BK/RB/WH	0.019	10'	25	35	875
AAF3310ML	Aluminum 3 x 3 (C5-1/2)	Mill	0.019	10'	25	35	875
AAF33310 - -	Aluminum 3 x 3 (C6)	BZ/RB/WH	0.032	10'	25	35	875
AAF33310ML	Aluminum 3 x 3 (C6)	Mill	0.032	10'	25	35	875
GAF3310 - -	Galvanized 3 x 3 (C6)	BK/RB/TB/WH	26 ga	10'	10	35	350
GAF3310ML	Galvanized 3 x 3 (C6)	Mill	26 ga	10'	10	35	350
GAF4410 - -	Galvanized 4 x 4 (C7)	BK/RB/TB/WH	26 ga	10'	10	35	350
GAF4410ML	Galvanized 4 x 4 (C7)	Mill	26 ga	10'	10	35	350

AAF2210, AAF22210

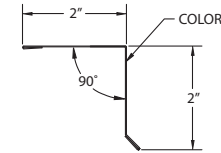

AAF32531

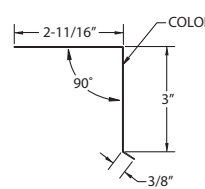

AAF33310

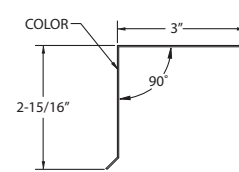

AAF3310, GAF3310

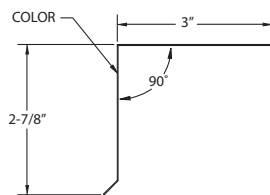

GAF4410

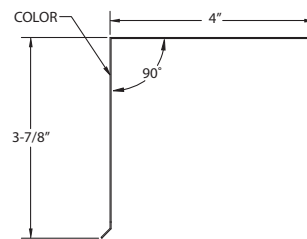

AAFN3310, GAFN3310

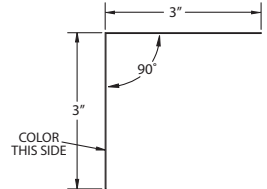

No Kick (Color Outside)

AAFN3310WH	Aluminum 3 x 3 (E6)	WH	0.019	10'	10	35	350
GAFN3310 - -	Galvanized 3 x 3 (E6)	BK/RB/TB/WH	26 ga	10'	10	35	350
GAFNR331 - -	Galv. 3 x 3 (E6) Reverse Color	BK/RB/TB/WH	26 ga	10'	10	35	350
GAFN3310ML	Galvanized 3 x 3 (E6)	Mill	26 ga	10'	10	35	350
GAFN4410 - -	Galvanized 4 x 4 (E8)	BK/RB/TB/WH	26 ga	10'	10	35	350
GAFNR441 - -	Galv. 4 x 4 (E8) Reverse Color	BK/RB/TB/WH	26 ga	10'	10	35	350
GAFN4410ML	Galvanized 4 x 4 (E8)	Mill	26 ga	10'	10	35	350
GAFN845 - -	Galvanized 4 x 5	RB, WH	28 ga	10'	10	35	350
GAFNR845RB	Galv. 4 x 5 (E8) Reverse Color	RB	26 ga	10'	10	35	350
GAFN845ML	Galvanized 4 x 5	Mill	28 ga	10'	10	35	350
GAFN8452 - -	Galvanized 4 x 5 120°	RB, WH	28 ga	10'	10	35	350
GAFN8452ML	Galvanized 4 x 5 120°	Mill	28 ga	10'	10	35	350

GAFNR331

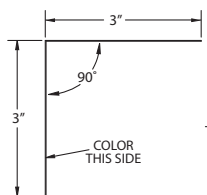

GAFN4410

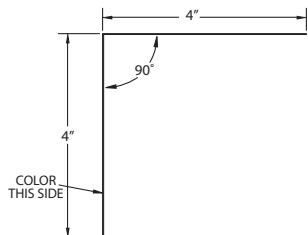

GAFNR441

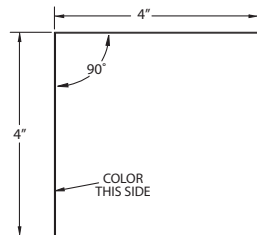

GAFN845



GAFN8452

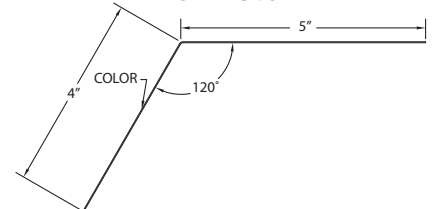

Roofing Accessories Colors:

COLOR	CODE	COLOR	CODE	COLOR	CODE	COLOR	CODE
BLACK	BK	ROYAL BROWN	RB	TERRA BRONZE	TB	WHITE	WH

Colorado Drip Edge

Part #	Description	Colors	Nom. Gauge/ Thickness	Piece Length	Pieces/ Bundle	Bundles/ Pallet	Pieces/ Pallet
GDE822	Galv. 2 x 2, 90° Dual Safety Hem	(Listed Below)	28 ga	10'	10	68	680
GDE822ML	Galv. 2 x 2, 90° Dual Safety Hem	Mill	28 ga	10'	10	68	680
GDE8222	Galv. 2 x 2, 120° Dual Safety Hem	(Listed Below)	28 ga	10'	10	68	680
GDE8222ML	Galv. 2 x 2, 120° Dual Safety Hem	Mill	28 ga	10'	10	68	680
GDE824	Galv. 2 x 4, 90° Dual Safety Hem	(Listed Below)	28 ga	10'	10	40	400
GDE824ML	Galv. 2 x 4, 90° Dual Safety Hem	Mill	28 ga	10'	10	40	400
GDE8242	Galv. 2 x 4, 120° Dual Safety Hem	(Listed Below)	28 ga	10'	10	40	400
GDE8242ML	Galv. 2 x 4, 120° Dual Safety Hem	Mill	28 ga	10'	10	40	400

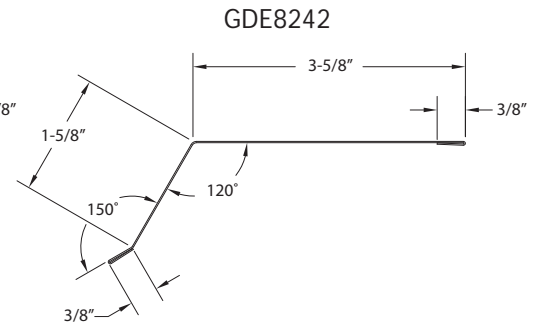
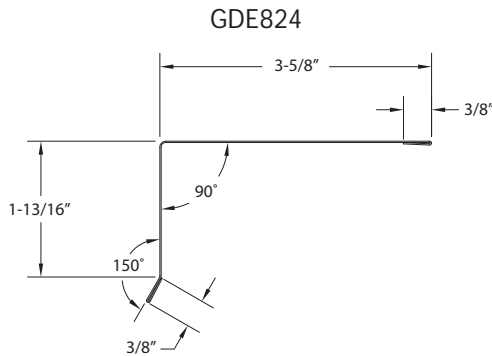
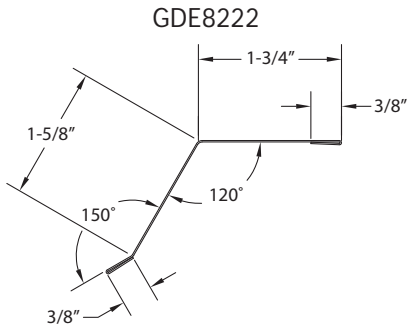
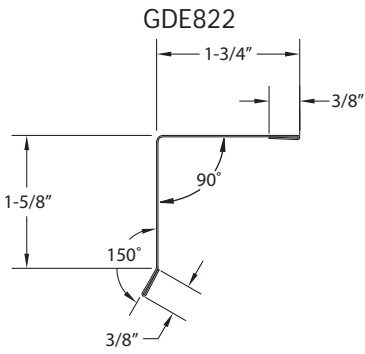

C-Channel

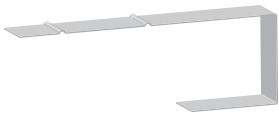

Part #	Description	Colors	Nom. Gauge/ Thickness	Piece Length	Pieces/ Box	Boxes/ Pallet	Pieces Pallet
ACC10	Aluminum 1"	BK/RB/TB/WH	0.019	10'	25	24	600
ACC15	Aluminum 1-1/2"	BK/RB/TB/WH	0.019	10'	25	24	600
ACC20	Aluminum 2"	BK/RB/TB/WH	0.019	10'	25	12	300
GCC10	Galvanized 1"	BK/RB/TB/WH	0.011	10'	25	24	600
GCC10ML	Galvanized 1"	Mill	0.011	10'	25	24	600
GCC15	Galvanized 1-1/2"	BK/RB/TB/WH	0.011	10'	25	24	600
GCC15ML	Galvanized 1-1/2"	Mill	0.011	10'	25	24	600
GCC20	Galvanized 2"	BK/RB/TB/WH	0.011	10'	25	24	600
GCC20ML	Galvanized 2"	Mill	0.011	10'	25	24	600

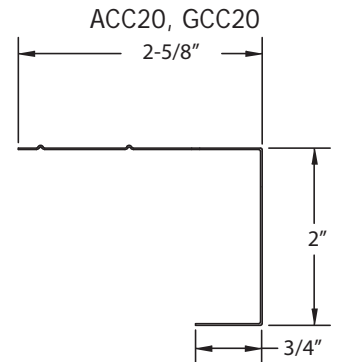
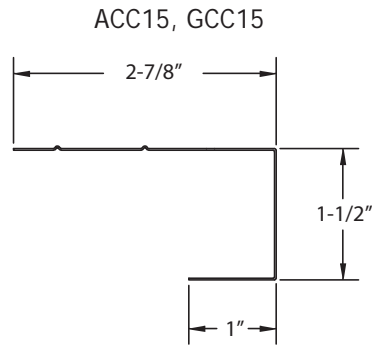
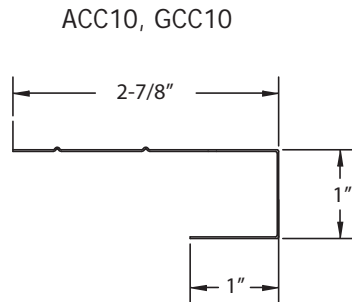

Roofing Accessories Colors:

COLOR	CODE	COLOR	CODE	COLOR	CODE	COLOR	CODE
BLACK	BK	EVERGREEN	EG	ROYAL BROWN	RB	TERRA BRONZE	TB
CHARCOAL GREY	CG	HARBOR GREY	HG	REDWOOD	RW	WHITE	WH
COUNTRY BLUE	CU						

Drip Edge

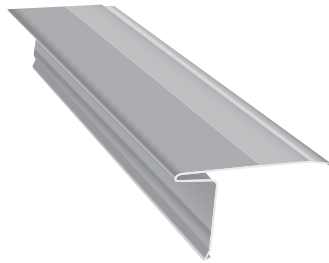

Part #	Description	Colors	Nom. Gauge/ Thickness	Piece Length	Pieces/ Box	Boxes/ Pallet	Pieces/ Pallet
Professional - Closed Face							
ADE10 - -	Aluminum 1" face with 2-7/8" back (F5)	*(Listed Below)	0.019	10'	50	24	1200
<i>*Also available in Montana Suede XMS.</i>							
ADE10ML	Aluminum 1" face with 2-7/8" back (F5)	Mill	0.019	10'	50	24	1200
ADE15 - -	Aluminum 1-1/2" face with 3" back	*(Listed Below)	0.019	10'	50	24	1200
ADE2415WH	Aluminum 1-1/2" face with 3" back	WH	0.024	10'	50	24	1200
ADE185 - -	Aluminum 1-3/4" face with 2-5/16" back	*(Listed Below)	0.019	10'	50	24	1200
GDE10 - -	Galvanized 1" face with 2-7/8" back (F5)	BK/RB/TB/WH	0.011	10'	25	24	600
GDE10ML	Galvanized 1" face (F5) with 2-7/8" back (F5)	Mill	0.011	10'	25	24	600
GDE15 - -	Galvanized 1-1/2" face with 3" back	BK/RB/TB/WH	30 ga	10'	25	24	600
GDE15ML	Galvanized 1-1/2" face with 3" back	Mill	30 ga	10'	25	24	600
GDE20 - -	Galvanized 2" face (ODE) with 3" back	BK/RB/TB/WH	0.011	10'	25	24	600
GDE20ML	Galvanized 2" face (ODE) with 3" back	Mill	0.011	10'	25	24	600
GDE2610 - -	Galvanized 1" closed face with 2-7/8" back	BK/NW/RB/TB/WH	26 ga	10'	20	24	480
GDE2615 - -	Galv. 1-1/2" closed face with 2-7/8" back	BK/NW/RB/TB/WH	26 ga	10'	25	18	450
GDE2615ML	Galv. 1-1/2" closed face with 2-7/8" back	Mill	26 ga	10'	25	18	450
CDE10	Copper 1" face with 2-7/8" back		10 oz.	10'	10	48	480
CDE15	Copper 1-1/2" face with 3" back		10 oz.	10'	10	48	480

**ADE15 & ADE185 not available in VI.*

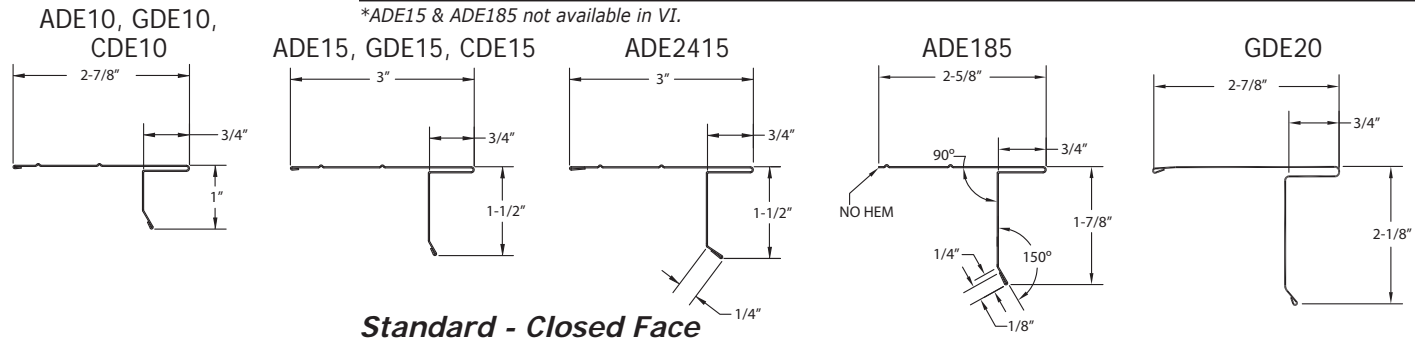

Standard - Closed Face

SAD10 - -	Aluminum 1" face (F4-1/2)	BK/MB/RB/TB/WH	0.019	10'	50	24	1200
ESAD10 - -	Economy Aluminum 1" face (FSN4-1/2)	RB/TB/WH	0.015	10'	50	24	1200
SAD125 - -	Aluminum 1-1/4" face	BK/MB/RB/TB/VG/WH	0.019	10'	50	24	1200
SAD15 - -	Aluminum 1-1/2" face (F5M)	BK/RB/TB/WH	0.019	10'	50	24	1200
SAD15ML	Aluminum 1-1/2" face (F5M)	Mill	0.019	10'	50	24	1200
SAD185 - -	Alumimun 1-3/4" face (ODE)	AL/BZ/BK/CL/MB/MS/RB/TB/WH	0.019	10'	50	24	1200
SGDE10 - -	Galvanized 1" face (F4-1/2)	BK/RB/TB/WH	0.011	10'	25	24	600
SGDE10ML	Galvanized 1" face (F4-1/2)	Mill	0.013	10'	25	24	600
SGDE125 - -	Galvanized 1-1/4" face	BK/RB/TB/WH	0.011	10'	25	24	600
SGDE125ML	Galvanized 1-1/4" face	Mill	0.011	10'	25	24	600
SGDE15 - -	Galvanized 1-1/2" face (F5M)	BK/RB/TB/WH	0.011	10'	25	24	600
SGDE15ML	Galvanized 1-1/2" face (F5M)	Mill	0.011	10'	25	24	600
SGDE185 - -	Galvanized 1-3/4" face (ODE)	BK/RB/TB/WH	0.011	10'	25	24	600
SGDE185ML	Galvanized 1-3/4" face (ODE)	Mill	0.011	10'	25	24	600

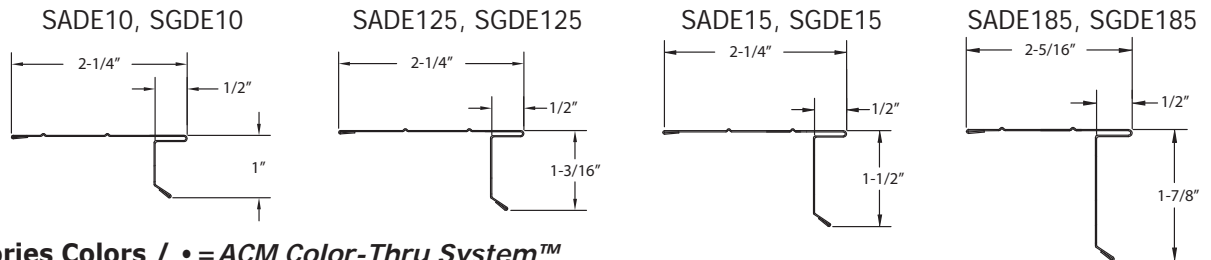

Roofing Accessories Colors / • = ACM Color-Thru System™

COLOR	CODE	COLOR	CODE	COLOR	CODE	COLOR	CODE	COLOR	CODE
• ALMOND	AL	• CAMEO	CA	• EVEREST	EV	• PEBBLESTONE CLAY	PC	• TERRA BRONZE	TB
• BEAVER BROWN	BB	• CHARCOAL GREY	CG	• EVERGREEN	EG	• REDWOOD	RW	• VICTORIAN GREY	VG
• BLACK	BK	• CLASSIC CREAM	CC	• HARBOR GREY	HG	• ROYAL BROWN	RB	• VILLAGE GREEN	VI
• BRONZE	BZ	• CLAY	CL	• LINEN	LI	• SAGE	SA	• WHITE	WH
• BROOKSTONE	BS	• COUNTRY BLUE	CU	• MUSKET BROWN	MB	• SANDTONE	ST	• WICKER	WI
• BUCKSKIN	BU	• DESERT SAND	DS	• NORWEGIAN WOOD	NW	• SILVER GREY	SG		

Drip Edge *cont.*

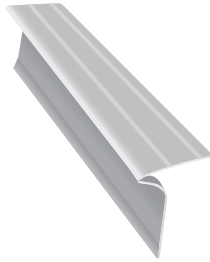

Part #	Description	Colors	Nom. Gauge/ Thickness	Piece Length	Pieces/ Box	Boxes/ Pallet	Pieces/ Pallet
<i>Professional - Open Face</i>							
ADEOF415 - -	Aluminum 1-1/2" open face with 2-1/2" back (F50)	BK/RB/TB/WH	0.019	10'	50	24	1200
ADEOF415ML	Aluminum 1-1/2" open face with 2-1/2" back (F50)	ML	0.019	10'	50	24	1200
ADEOF10 - -	Aluminum 1-1/2" open face with 4" back (F5-1/20)	BK/RB/TB/WH	0.019	10'	50	24	1200
ADEOF10ML	Aluminum 1-1/2" open face with 4" back (F5-1/20)	Mill	0.019	10'	50	24	1200
<hr/>							
GDEOF415 - -	Galvanized 1-1/2" open face with 2-1/2" back (F50)	BK/RB/TB/WH	0.011	10'	25	32	800
GDEOF415ML	Galvanized 1-1/2" open face with 2-1/2" back (F50)	Mill	0.011	10'	25	32	800

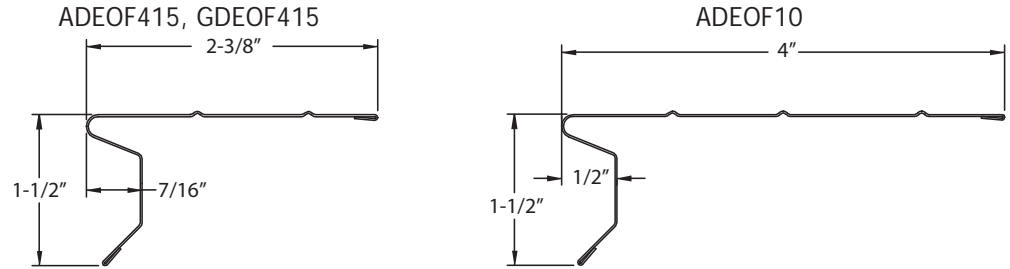

F-8 Large - Open Face

ADEF8 - -	Aluminum 1-1/2" open face with 5-3/4" back (F8)	BK/RB/TB/WH	0.019	10'	25	24	600
ADEF8ML	Aluminum 1-1/2" open face with 5-3/4" back (F8)	Mill	0.019	10'	25	24	600
EADEF8 - -	Economy Aluminum 1-1/2" (F8)	RB/WH	0.015	10'	25	24	600
<hr/>							
GDEF8 - -	Galvanized 1-1/2" open face with 5-3/4" back (F8)	BK/RB/TB/WH	0.011	10'	15	24	360
GDEF8ML	Galvanized 1-1/2" open face with 5-3/4" back (F8)	Mill	0.011	10'	15	24	360

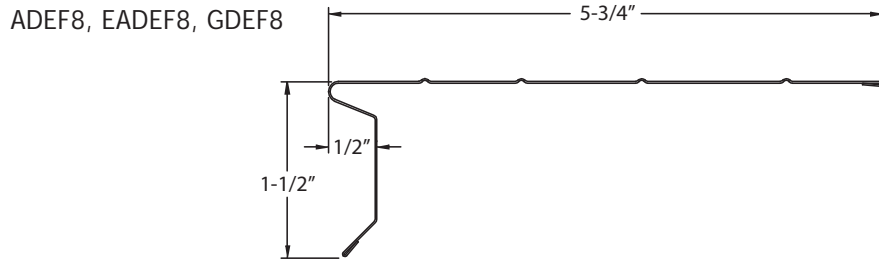

26 Gauge Galvanized - Open Face

GDEOF615 --	Galvanized 2" open face with 3-1/2" back	BK/RB/TB/WH	26 ga	10'	20	24	480
GDEOF625 --	Galvanized 2-3/4" open face with 2-5/8" back	BK/RB/TB/WH	26 ga	10'	20	24	480
GDEOF630 --	Galvanized 3-1/4" open face with 2-9/16" back	BK/RB/TB/WH	26 ga	10'	20	24	480

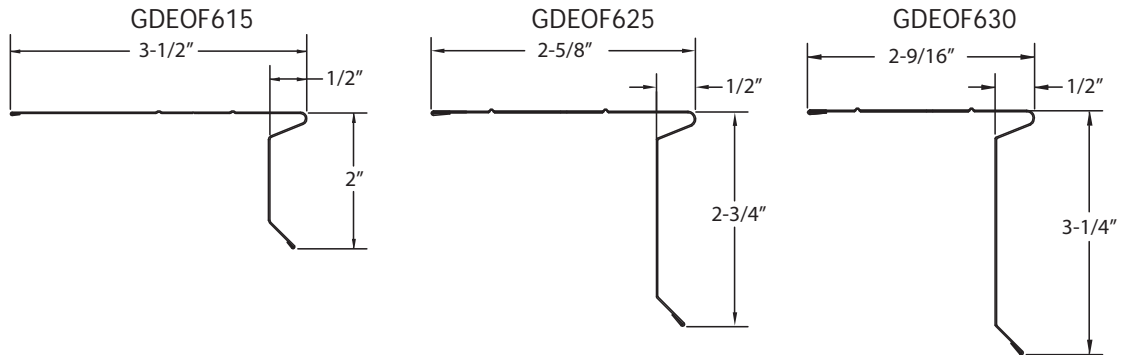

Roofing Accessories Colors:

COLOR	CODE	COLOR	CODE	COLOR	CODE	COLOR	CODE
BLACK	BK	ROYAL BROWN	RB	TERRA BRONZE	TB	WHITE	WH

Rake Edge 90°

Part #	Description	Colors	Nom. Gauge/ Thickness	Piece Length	Pieces/ Box	Boxes/ Pallet	Pieces/ Pallet
Professional							
ARK10 - -	Alum. 1" face with 2-3/4" back	BK/RB/TB/WH	0.019	10'	50	27	1350
ARK15 - -	Alum. 1-1/2" face with 2-11/16" back	BK/RB/TB/WH	0.019	10'	50	27	1350
ARK25 - -	Alum. 2-1/2" face with 2-7/16" back (C5-1/2)	BK/RB/TB/WH	0.019	10'	50	27	1350
ARKC315 - -	Alum. 1-1/2" crown face with 2-3/16" back (C3-1/2)	RB/WH	0.019	10'	50	32	1600
ARKC315ML	Alum. 1-1/2" crown face with 2-3/16" back (C3-1/2)	Mill	0.019	10'	50	32	1600
EARKC315 - -	Econ. Alum. 1-1/2" crown face with 2-3/16" back (C3-1/2)	WH/RB	0.015	10'	50	32	1600
GRK10 - -	Galv. 1" face with 2-3/4" back	BK/RB/TB/WH	0.011	10'	25	27	675
GRK10ML	Galv. 1" face with 2-3/4" back	Mill	0.013	10'	25	27	675
GRK15 - -	Galv. 1-1/2" face with 2-11/16" back	BK/RB/TB/WH	0.011	10'	25	27	675
GRK15ML	Galv. 1-1/2" face with 2-11/16" back	Mill	0.011	10'	25	27	675
GRK25 - -	Galv. 2-1/2" face with 2-7/16" back (C5-1/2)	BK/RB/TB/WH	0.011	10'	25	27	675
GRK25ML	Galv. 2-1/2" face with 2-7/16" back (C5-1/2)	Mill	0.011	10'	25	27	675

ARK10, GRK10

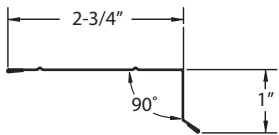

ARK15, GRK15

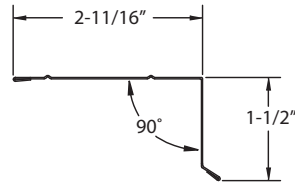

ARK25, GRK25

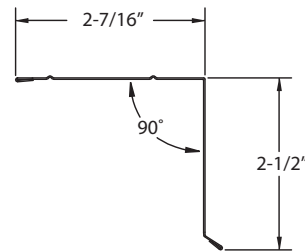

ARKC315, EARKC315

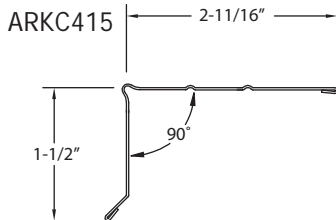
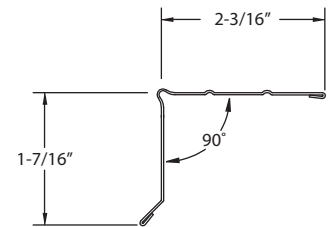
**Professional 2-3/4" Back Crown Face**

ARKC415 - -	Aluminum 1-1/2" crown face (C4-1/2)	RB/WH	0.019	10'	50	27	1350
ARKC415ML	Aluminum 1-1/2" crown face (C4-1/2)	Mill	0.019	10'	50	27	1350

Standard

SARK10 - -	Aluminum 1" face with 1-11/16" back	BK/RB/TB/WH	0.019	10'	50	27	1350
SARK20 - -	Aluminum 2" face with 1-7/8" back (C4)	BK/RB/TB/WH	0.019	10'	50	27	1350
SARK25 - -	Aluminum 2-1/2" face with 2-1/16" back	BK/RB/TB/WH	0.019	10'	50	27	1350
SGRK10 - -	Galvanized 1" face with 1-11/16" back	BK/RB/TB/WH	0.011	10'	50	27	1350
SGRK10ML	Galvanized 1" face with 1-11/16" back	Mill	0.013	10'	50	27	1350
SGRK20 - -	Galvanized 2" face with 1-7/8" back (C4)	BK/RB/TB/WH	0.011	10'	25	27	675
SGRK20ML	Galvanized 2" face with 1-7/8" back (C4)	Mill	0.011	10'	25	27	675

26 Gauge

SGRK2610 - -	Galvanized 1" face with 1-5/8" back	BK/RB/TB/WH	26 ga	10'	25	27	675
SGRK2610ML	Galvanized 1" face with 1-5/8" back	Mill	26 ga	10'	25	27	675

SARK10, SGRK10

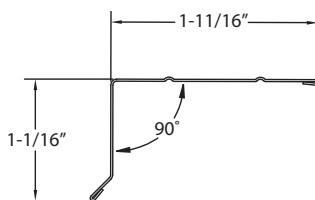

SARK20, SGRK20

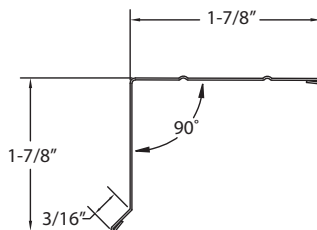

SARK25

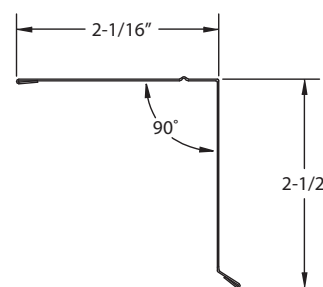

SGRK2610

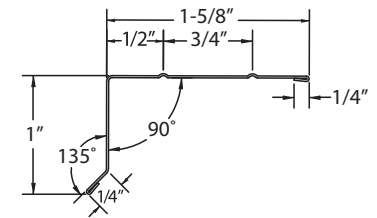
**Roofing Accessories Colors:**

COLOR	CODE	COLOR	CODE	COLOR	CODE	COLOR	CODE
BLACK	BK	ROYAL BROWN	RB	TERRA BRONZE	TB	WHITE	WH

Gravel Stop



Part #	Description	Color	Nom. Gauge/ Thickness	Piece Length	Pieces/ Box	Boxes/ Pallet	Pieces/ Pallet
AGS30 - -	Aluminum 3" face (H6F)	BK/RB/TB/WH	0.019	10'	25	20	500
AGS40 - -	Aluminum 4" face (H7)	BK/RB/TB/WH	0.019	10'	25	20	500
AGS30 - -	Galvanized 3" face (H6F)	BK/RB/TB/WH	26 ga	10'	10	35	350
AGS30ML	Galvanized 3" face (H6F)	Mill	26 ga	10'	10	35	350
AGS40 - -	Galvanized 4" face (H7)	BK/RB/TB/WH	26 ga	10'	10	35	350
AGS40ML	Galvanized 4" face (H7)	Mill	26 ga	10'	10	35	350

AGS30, GGS30

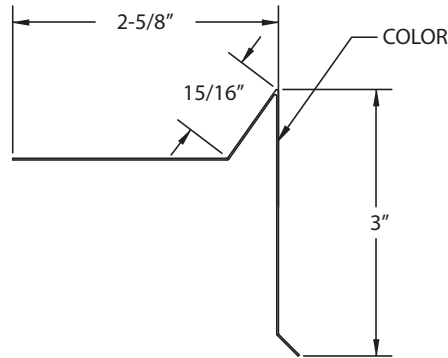

AGS40, GGS40

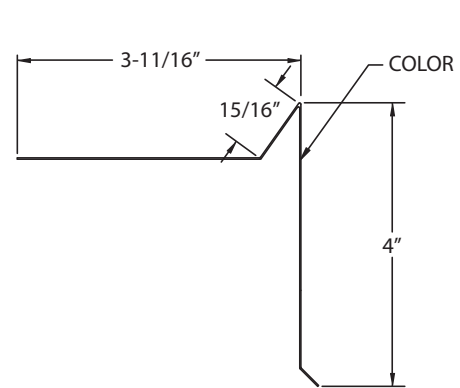

Gutter Apron 25°



Part #	Description	Color	Nom. Gauge/ Thickness	Piece Length	Pieces/ Box	Boxes/ Pallet	Pieces/ Pallet
AGA15 - -	Aluminum 1-1/2" face	BK/RB/TB/WH	0.019	10'	50	32	1600
AGA20 - -	Aluminum 2" face	*(Listed Below)	0.019	10'	50	32	1600
GGA15 - -	Galvanized 1-1/2" face	BK/RB/TB/WH	0.011	10'	25	32	800
GGA15ML	Galvanized 1-1/2" face	Mill	0.013	10'	25	32	800
GGA20 - -	Galvanized 2" face	BK/RB/TB/WH	0.011	10'	25	32	800
GGA20ML	Galvanized 2" face	Mill	0.011	10'	25	32	800
GGA2620 - -	Galvanized 2" face	BK/NW/RB/TB/WH	26 ga	10'	25	32	800
CGA20	Copper 2" face		10 oz	10'	10	32	320

*AGA20 not available in VI.

AGA15, GGA15

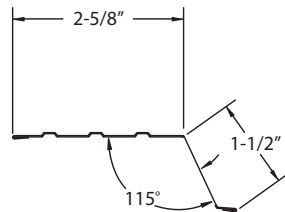

AGA20, GGA20

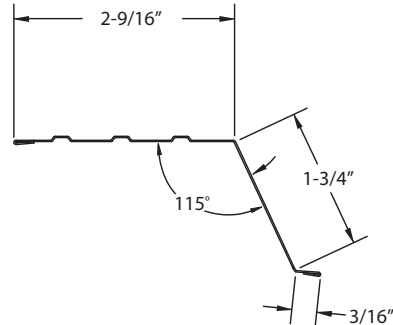

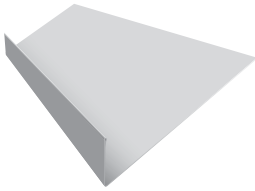

Roofing Accessories Colors / • = ACM Color-Thru System™

COLOR	CODE	COLOR	CODE	COLOR	CODE	COLOR	CODE	COLOR	CODE
• ALMOND	AL	• CAMEO	CA	• EVEREST	EV	• NORWEGIAN WOOD	NW	• SILVER GREY	SG
• BEAVER BROWN	BB	• CHARCOAL GREY	CG	• EVERGREEN	EG	• PEBBLESTONE CLAY	PC	• TERRA BRONZE	TB
• BLACK	BK	• CLASSIC CREAM	CC	• HARBOR GREY	HG	• REDWOOD	RW	• VICTORIAN GREY	VG
• BRONZE	BZ	• CLAY	CL	• LINEN	LI	• ROYAL BROWN	RB	• VILLAGE GREEN	VI
• BROOKSTONE	BS	• COUNTRY BLUE	CU	• MONTANA SUEDE	XMS	• SAGE	SA	• WHITE	WH
• BUCKSKIN	BU	• DESERT SAND	DS	• MUSKET BROWN	MB	• SANDTONE	ST	• WICKER	WI

Rain Diverter		Part #	Description	Colors	Nom. Gauge/ Thickness	Piece Length	Pieces/ Box	Boxes/ Pallet	Pieces/ Pallet
		GRD710 - -	Galvanized 7"	BK/RB/TB/WH	26 ga	10'	10	25	250
		GRD710ML	Galvanized 7"	Mill	26 ga	10'	10	25	250

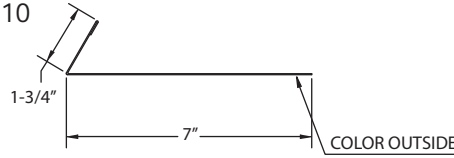
GRD710



Reglet Flashing		Part #	Description	Colors	Nom. Gauge/ Thickness	Piece Length	Pieces/ Box	Boxes/ Pallet	Pieces/ Pallet
		GRF410 - -	Galvanized 4"	BK/RB/TB/WH	26 ga	10'	10	25	250
		GRF410ML	Galvanized 4"	Mill	26 ga	10'	10	25	250
		CRF410	Copper 4"		16 oz	10'	Order by the pc.		

GRF410, CRF410

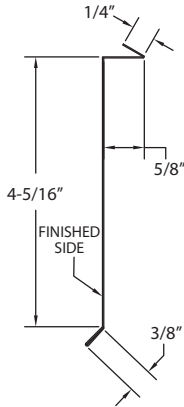

Counter Flashing		Part #	Description	Colors	Nom. Gauge/ Thickness	Piece Length	Pieces/ Box	Boxes/ Pallet	Pieces/ Pallet
		GCF710ML	Galvanized 8"	Mill	0.017	10'	10	25	250
		GCF510ML	Galvanized 5 x 10	Mill	0.017	10'	10	25	250
		GCF510 - -	Galvanized 5 x 10	BK/CG/HG/RB/WH	0.017	10'	10	25	250
		GLCF510ML	5" Colorado Counter Flashing	Mill	0.017	10'	10	25	250
		GLCF510 - -	5" Colorado Counter Flashing	CG/HB/RB/WH	0.017	10'	10	25	250

GCF710ML

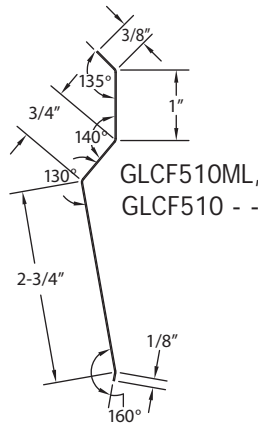
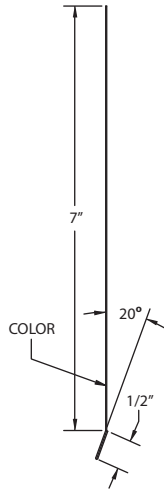

Chimney Flashing		Part #	Description	Pieces/ Box	Boxes/ Pallet
		SCACFK - -	ACM Stone Coat Chimney Flashing Kit Kit will cover up to 3' x 3' chimney.	1	14

ACM Stone Coat is available in these roof granule blends: B3 - Bark Brown, BH - Beach Brown, BK - Black, C4 - Cedarwood, C3 - Charcoal, S6 - Sierra Brown, WW - Weatherwood, GN - Green, MU - Musket Pebble, PE - Pearl White.

ACM Stone Coat
Chimney Flashing Kit

Roofing Accessories Colors:

COLOR	CODE	COLOR	CODE	COLOR	CODE	COLOR	CODE
BLACK	BK	HARBOR GREY	HG	TERRA BRONZE	TB	WHITE	WH
CHARCOAL GREY	CG	ROYAL BROWN	RB				

Flashing Sheet

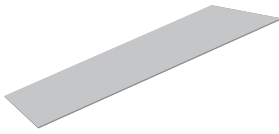

Part #	Description	Nom. Gauge/ Thickness	Piece Length	Pieces/ Box	Pieces/ Pallet
CFS2410	Copper 24" x 10'	16 oz	10'	Order by the pc.	55
CFS368	Copper 36" x 8'	16 oz	8'	Order by the pc.	45
CFS3610	Copper 36" x 10'	16 oz	10'	Order by the pc.	36

Flat Shingle



Part #	Description	Color	Nom. Gauge/ Thickness	Piece Length	Pieces/ Bundle	Pieces/ Box
ASF57TBWH	Aluminum 5 x 7	TBWH	0.011	7"	100	500
ASF57BKRB	Aluminum 5 x 7	BKRB	0.011	7"	100	500
ASF57ML	Aluminum 5 x 7	Mill	0.011	7"	100	500
ASF1768ML	Aluminum 6 x 8	Mill	0.017	8"	100	500
ASF68BKRB	Aluminum 6 x 8	BKRB	0.011	8"	100	500
ASF68TBWH	Aluminum 6 x 8	TBWH	0.011	8"	100	500
ASF68ML	Aluminum 6 x 8	Mill	0.011	8"	100	500
ASF710TBWH	Aluminum 7 x 10	TBWH	0.011	10"	100	500
ASF710BKRB	Aluminum 7 x 10	BKRB	0.011	10"	100	500
ASF710ML	Aluminum 7 x 10	Mill	0.011	10"	100	500
ASF88TBWH	Aluminum 8 x 8	TBWH	0.011	8"	100	500
ASF88BKRB	Aluminum 8 x 8	BKRB	0.011	8"	100	500
ASF88ML	Aluminum 8 x 8	Mill	0.011	8"	100	500
ASF2885WH	Aluminum 8 x 8	WH	0.024	8"	50	500
ASF810ML	Aluminum 8 x 10	Mill	0.011	10"	100	500
GSF57ML	Galvanized 5 x 7	Mill	0.009	7"	100	
GSF68 - -	Galvanized 6 x 8	BK/RB/TB	0.011	8"	100	
GSF68ML	Galvanized 6 x 8	Mill	0.011	8"	100	
GSF88 - -	Galvanized 8 x 8	BK/RB/TB/WH	0.011	8"	100	
GSF88ML	Galvanized 8 x 8	Mill	0.009	8"	100	
GSF814 - -	Galvanized 8 x 14	BK/RB/TB/WH	0.011	14"	25	
GSF814ML	Galvanized 8 x 14	Mill	0.009	14"	25	
CSF57	Copper 5 x 7		16 oz	7"	100	

ASF57, GSF57, CSF57

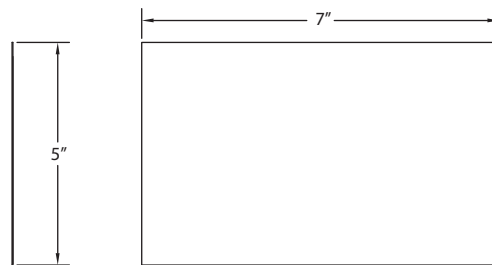

ASF68, GSF68

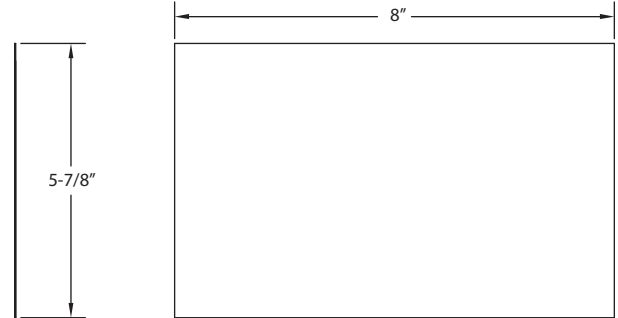

Roofing Accessories Colors:

COLOR	CODE	COLOR	CODE	COLOR	CODE	COLOR	CODE
BLACK	BK	ROYAL BROWN	RB	TERRA BRONZE	TB	WHITE	WH

Pre-Bent Step Flashing



Part #	Description	Color	Nom. Gauge/ Thickness	Pieces Length	Pieces/ Bundle	Pieces/ Box
APSF57 - -	Aluminum 2-1/2 x 2-1/2 x 7	BK/RB/TB/WH	0.011	7"	100	500
APSF57ML	Aluminum 2-1/2 x 2-1/2 x 7	Mill	0.011	7"	100	500
APSF237 - -	Aluminum 2 x 3 x 7	BK/RB	0.011	7"	100	500
APSF237ML	Aluminum 2 x 3 x 7	Mill	0.011	7"	100	500
APSF347 - -	Aluminum 3 x 4 x 7	BK/RB/TB	0.011	7"	100	500
APSF347ML	Aluminum 3 x 4 x 7	Mill	0.011	7"	100	500
APSF68 - -	Aluminum 3 x 3 x 8	BK/RB	0.011	8"	100	500
APSF68ML	Aluminum 3 x 3 x 8	Mill	0.011	8"	100	500
APSF88 - -	Aluminum 4 x 4 x 8	BK/RB/TB/WH	0.011	8"	100	500
APSF88ML	Aluminum 4 x 4 x 8	Mill	0.011	8"	100	500
APSF2885 - -	Aluminum 4 x 4 x 8	BK/RB/WH	0.024	8"	50	250
APSF557 - -	Aluminum 5 x 5 x 7	BK/RB/TB	0.011	7"	100	500
APSF557ML	Aluminum 5 x 5 x 7	Mill	0.011	7"	100	500
APSF5585 - -	Aluminum 5 x 5 x 8	BK/RB	0.011	8"	50	250
APSF5585ML	Aluminum 5 x 5 x 8	Mill	0.011	8"	50	250
APSF558 - -	Aluminum 5 x 5 x 8	BK/RB	0.011	8"	100	500
APSF558ML	Aluminum 5 x 5 x 8	Mill	0.011	8"	100	500
<hr/>						
GPSF57 - -	Galvanized 2-1/2 x 2-1/2 x 7	BK/RB/TB	0.011	7"	100	
GPSF57ML	Galvanized 2-1/2 x 2-1/2 x 7	Mill	0.009	7"	100	
GPSF237 - -	Galvanized 2 x 3 x 7	BK/RB/TB/WH	0.013	7"	100	
GPSF237ML	Galvanized 2 x 3 x 7	Mill	0.009	7"	100	
GPSF88 - -	Galvanized 4 x 4 x 8	BK/RB/TB/WH	28 ga	8"	100	
GPSF88ML	Galvanized 4 x 4 x 8	Mill	30 ga	8"	100	
GPSF814 - -	Galvanized 4 x 4 x 14	BK/RB/TB/WH	0.011	14"	25	
GPSF814ML	Galvanized 4 x 4 x 14	Mill	0.009	14"	25	
GPSF914ML	Galvanized 4 x 5 x 14	Mill	0.009	14"	25	
<hr/>						
CPSF57	Copper 2-1/2 x 2-1/2 x 7		10 oz	7"		Order by the pc.
CPSF88	Copper 4 x 4 x 8		10 oz	8"		Order by the pc.
CPSF814	Copper 4 x 4 x 14		10 oz	14"		Order by the pc.
CPSF914	Copper 4 x 5 x 14		10 oz	14"		Order by the pc.

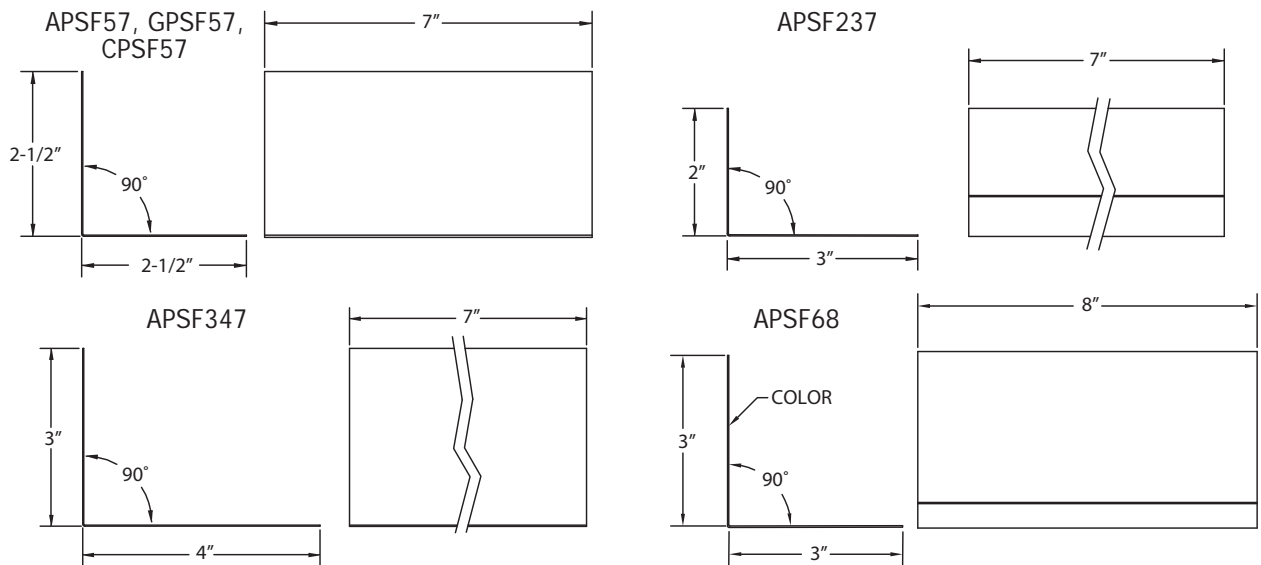

Roofing Accessories Colors:

COLOR	CODE	COLOR	CODE	COLOR	CODE	COLOR	CODE
BLACK	BK	ROYAL BROWN	RB	TERRA BRONZE	TB	WHITE	WH

Pre-Bent Step Flashing *cont.*

APSF88, GPSF88

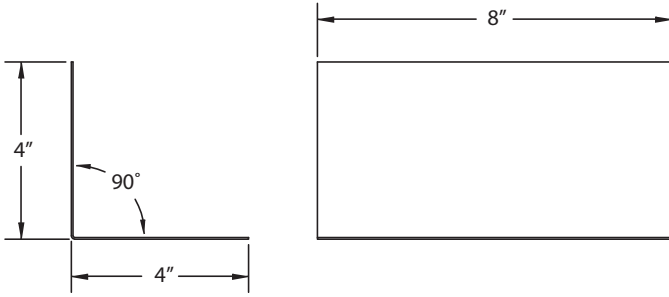

APSF557

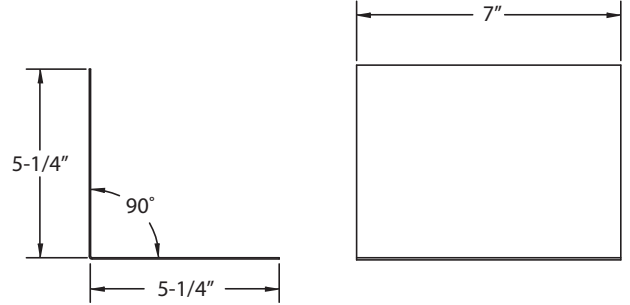

APSF558

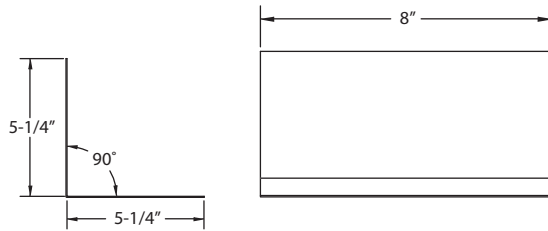

GPSF237

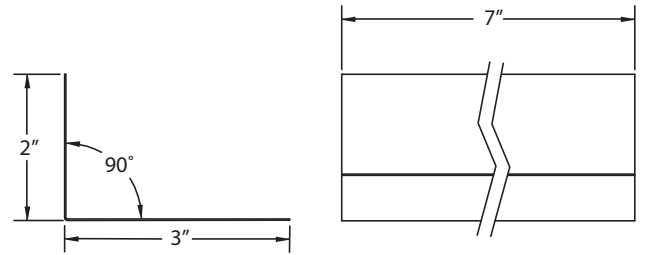

GPSF814, CPSF814

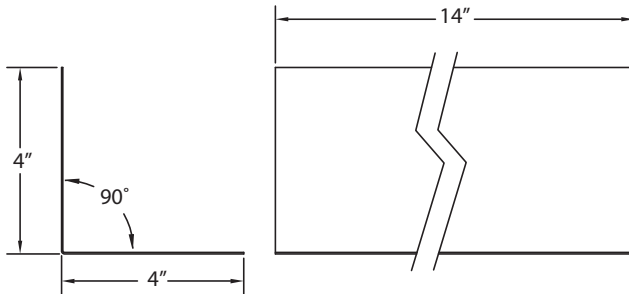

GPSF914, CPSF914

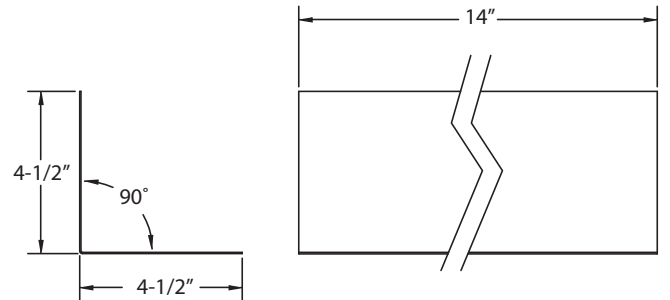

Roofing Accessories Colors:

COLOR	CODE	COLOR	CODE	COLOR	CODE	COLOR	CODE
BLACK	BK	ROYAL BROWN	RB	TERRA BRONZE	TB	WHITE	WH

Roll Valley



Part #	Description	Colors	Nom. Gauge/ Thickness	Piece Length	Pieces/ Box	Boxes/ Pallet	Pieces/ Pallet
ARV6ML	Aluminum 6"	Mill	0.011	50'	1	25	25
ARV8ML	Aluminum 8"	Mill	0.011	50'	1	25	25
ARV178ML	Aluminum 8"	Mill	0.019	50'	1	25	25
ARV10ML	Aluminum 10"	Mill	0.011	50'	1	25	25
ARV12ML	Aluminum 12"	Mill	0.011	50'	1	25	25
ARV14ML	Aluminum 14"	Mill	0.011	50'	1	25	25
ARV20ML	Aluminum 20"	Mill	0.011	50'	1	25	25
GRV8 - -	Galvanized 8"	RB/TB	30 ga	50'	1	25	25
GRV8ML	Galvanized 8"	Mill	32 ga	50'	1	25	25
GRV10 - -	Galvanized 10"	TB	30 ga	50'	1	25	25
GRV10 - - - -	Galvanized 10"	TBRB	30 ga	50'	1	25	25
GRV10ML	Galvanized 10"	Mill	32 ga	50'	1	25	25
GRV12ML	Galvanized 12"	Mill	32 ga	50'	1	25	25
GRV14ML	Galvanized 14"	Mill	32 ga	50'	1	25	25
GRV16ML	Galvanized 16"	Mill	32 ga	50'	1	25	25
GRV20 - -	Galvanized 20"	BK/RB/TB	30 ga	50'	1	25	25
GRV20ML	Galvanized 20"	Mill	32 ga	50'	1	25	25
GRV24ML	Galvanized 24"	Mill	32 ga	50'	1	25	25
CRV112	Copper 12"	100 lb	10 oz	100'	1		
CRV114	Copper 14"	100 lb	10 oz	85'	1		
CRV116	Copper 16"	80 lb	10 oz	60'	1		
CRV120	Copper 20"	100 lb	10 oz	60'	1		
CRV124	Copper 24"	100 lb	10 oz	50'	1		

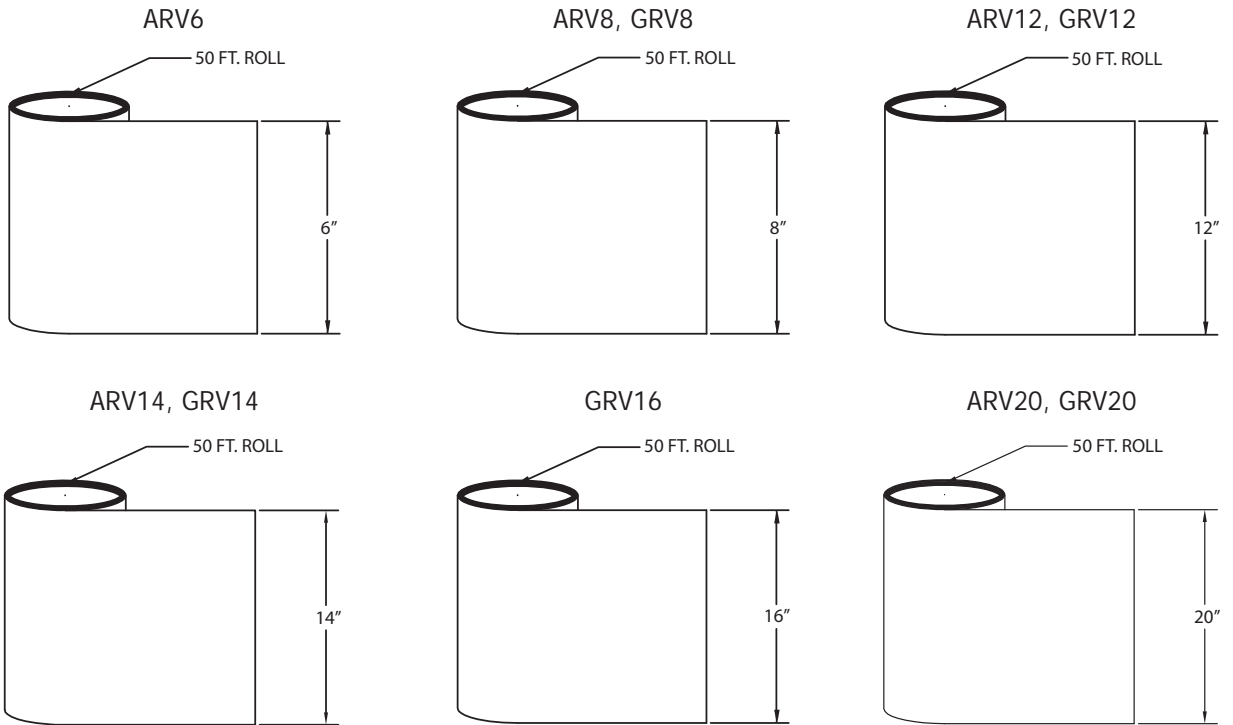

Roofing Accessories Colors:

COLOR	CODE	COLOR	CODE	COLOR	CODE
BLACK	BK	ROYAL BROWN	RB	TERRA BRONZE	TB

Roof to Wall Flashing

Part #	Description	Colors	Nom. Gauge/ Thickness	Piece Length	Pieces/ Box	Boxes/ Pallet	Pieces/ Pallet
ARTW3310 - -	Aluminum 3 x 3	BK/RB/TB/WH	0.019	10'	25	25	625
ARTW4410 - -	Aluminum 4 x 4	BK/RB/TB/WH	0.019	10'	25	25	625
GRTW3310 - -	Galvanized 3 x 3	BK/RB/TB/WH	26 ga	10'	10	25	250
GRTW3310ML	Galvanized 3 x 3	Mill	26 ga	10'	10	25	250
GRTW4410 - -	Galvanized 4 x 4	BK/RB/TB/WH	26 ga	10'	10	25	250
GRTW4410ML	Galvanized 4 x 4	Mill	26 ga	10'	10	10	250
CRTW4410	Copper 4 x 4		16 oz	10'	10	10	250
SCARW4410 - -	ACM Stone Coat 4x4 10'				10	24	240

ACM Stone Coat is available in these roof granule blends: B3 - Bark Brown, BH - Beach Brown, BK - Black, C4 - Cedarwood, C3 - Charcoal, S6 - Sierra Brown, WW - Weatherwood, GN - Green, MU - Musket Pebble, PE - Pearl White.

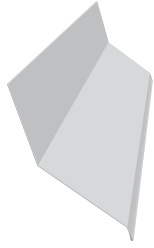

ACM Stone Coat 4x4
Roof to Wall Flashing

ARTW3310, GRTW3310

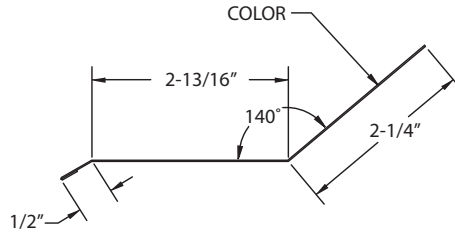

ARTW4410, GRTW4410, CRTW4410, SCARW4410

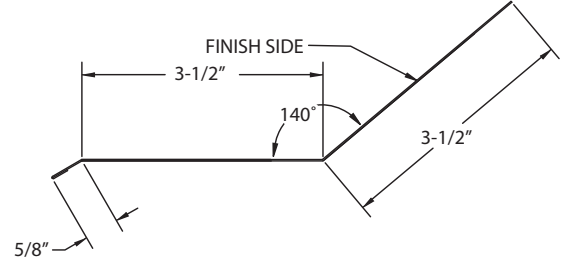

Roofing Accessories Colors:

COLOR	CODE	COLOR	CODE	COLOR	CODE	COLOR	CODE
BLACK	BK	ROYAL BROWN	RB	TERRA BRONZE	TB	WHITE	WH

Side Wall Flashing

Part #	Description	Colors	Nom. Gauge/ Thickness	Piece Length	Pieces/ Box	Boxes/ Pallet	Pieces/ Pallet
ASWF4410 - -	Aluminum 4 x 4	BK/RB/TB/WH	0.019	10'	10	14	140
GSWF4410 - -	Galvanized 4 x 4	BK/RB/TB/WH	26 ga	10'	10	35	350
GSWF4410ML	Galvanized 4 x 4	Mill	26 ga	10'	10	35	350
GSWF6610ML	Galvanized 6 x 6	Mill	26 ga	10'	10	35	350
GSWF5710ML	Galvanized 5 x 7	Mill	26 ga	10'	10	35	350

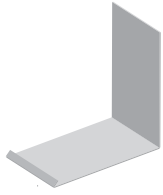

ASWF4410, GSWF4410

GSWF6610

GSWF5710

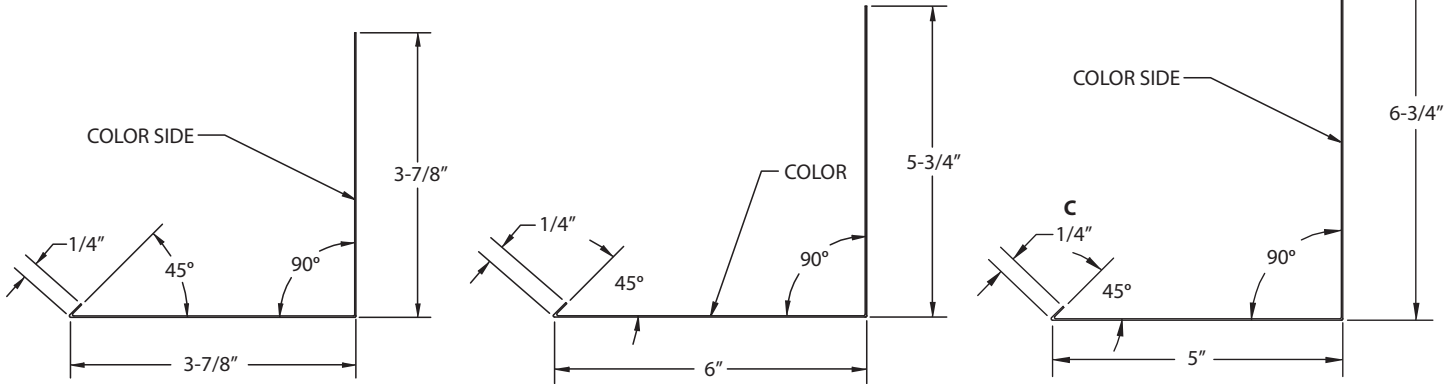

Tile Pan Flashing

Part #	Description	Colors	Nom. Gauge/ Thickness	Piece Length	Pieces/ Box	Boxes/ Pallet	Pieces/ Pallet
GTP6561ML	Galvanized Tile Pan 5 x 6 x 1	Mill	26 ga	10'	10	35	350



GTP6561ML

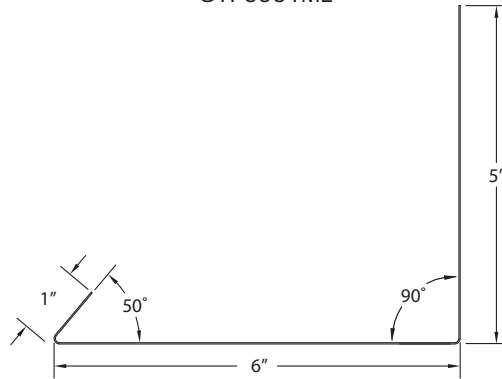

Roofing Accessories Colors:

COLOR	CODE	COLOR	CODE	COLOR	CODE	COLOR	CODE
BLACK	BK	ROYAL BROWN	RB	TERRA BRONZE	TB	WHITE	WH

W-Valley

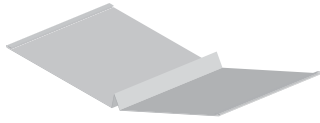

Part #	Description	Colors	Nom. Gauge/ Thickness	Piece Length	Pieces/ Box	Pieces/ Pallet
AWV24 - -	Aluminum 24"	BK/BZ/RB/TB	0.019	10'		100
AWV224 - -	Aluminum 24"	BK/RB/MB/WH	0.024	10'		100
AWV224ML	Aluminum 24"	Mill	0.024	10'		100
GWV18 - -	Galvanized 18"	BK/RB/TB/WH	30 ga	10'		100
GWV18ML	Galvanized 18"	Mill	30 ga	10'		100
GWV20 - -	Galvanized 20"	BK/RB/TB/WH	30 ga	10'		100
GWV20ML	Galvanized 20"	Mill	30 ga	10'		100
CWV18	Copper 18"		16 oz	10'	Order by the pc.	
CWV24	Copper 24"		16 oz	10'	Order by the pc.	

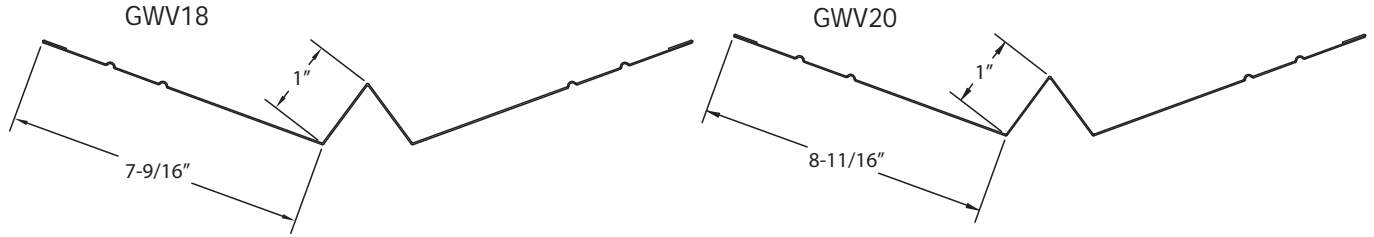

W-Valley - Professional

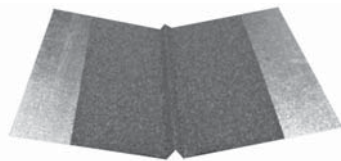

ACM Stone Coat
W-Valley Flashing

Part #	Description	Colors	Nom. Gauge/ Thickness	Piece Length	Pieces/ Box	Pieces/ Pallet	Boxes/ Pallet
GWV2820 - -	Galvanized 20"	BK/RB/TB	28 ga	10'		100	
GWV24 - -	Galvanized 24"	BK/RB/TB/WH	0.013	10'		100	
GWV24ML	Galvanized 24"	Mill	0.013	10'		100	
GWV2620 - -	Galvanized 20"	BK/RB/TB	26 ga	10'		100	
GWV2624 - -	Galvanized 24"	BK/RB/TB	26 ga	10'		100	
GWV2624ML	Galvanized 24"	Mill	26 ga	10'		100	
GWV2824 - -	Galvanized 24"	CG/RB	0.017	10'		100	
GWV2824ML	Galvanized 24"	Mill	0.017	10'		100	
SCGWV24 - -	ACM Stone Coat 24"			10'	Order by the pc.	75	

ACM Stone Coat is available in these roof granule blends: B3 - Bark Brown, BH - Beach Brown, BK - Black, C4 - Cedarwood, C3 - Charcoal, S6 - Sierra Brown, WW - Weatherwood, GN - Green, MU - Musket Pebble, PE - Pearl White.

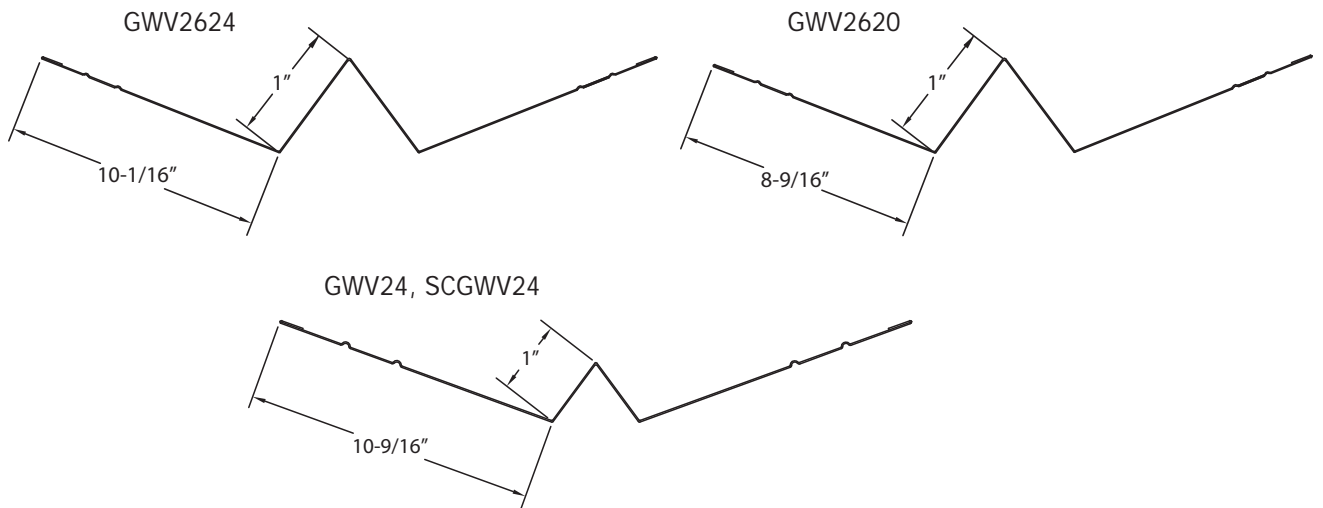

Roofing Accessories Colors:

COLOR	CODE	COLOR	CODE	COLOR	CODE	COLOR	CODE
BLACK	BK	CHARCOAL GREY	CG	ROYAL BROWN	RB	WHITE	WH
BRONZE	BZ	MUSKET BROWN	MB	TERRA BRONZE	TB		

ACM Stone Coat Ventilation Part # Description Colors Pieces/Box Boxes/Pallet

Roof Vents

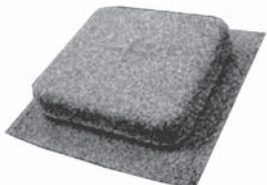

Mushroom Roof Vent

SCARVA51 - - Mushroom Roof Vent *(Listed Below) 8 9
Mushroom vent is used for pitches 8/12 or less and provides 50 square inches of net free air flow per vent.

SCASLA - - Slant Back Roof Vent *(Listed Below) 6 9
Slant backs can be used on most roof pitches and provides 50 square inches of net free air flow per vent. The slanted portion keeps water from coming in the back of the vent and has a guard to keep out bird nests.

**ACM Stone Coat is available in these roof granule blends: B3 - Bark Brown, BH - Beach Brown, BK - Black, C4 - Cedarwood, C3 - Charcoal, S6 - Sierra Brown, WW - Weatherwood, GN - Green, MU - Musket Pebble, PE - Pearl White.*

Mushroom or Slant Back Roof Vents

TL Attic Sq. Footage	Number of Vents	Net Free Area Square Inches
0-1000	5	250
1001-1500	7	350
1501-2000	10	500
2001-2500	12	600
2501-3000	15	750

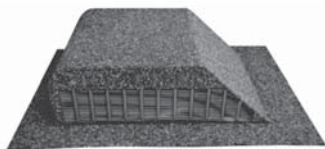

Slant Back Roof Vent

Z Flashing



Z Flashing

Part No.	"A"	"B"
A/GZF38	3/8"	2-1/4"
A/GZF44	7/16"	2-1/8"
A/GZF50	1/2"	2-1/16"
A/GZF62	5/8"	2"
A/GZF75	3/4"	1-7/8"

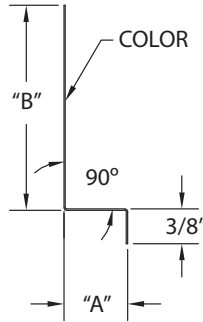

Part #	Description	Colors	Nom. Gauge/ Thickness	Piece Length	Pieces/ Box	Pieces/ Pallet
AZF38 - -	Aluminum 3/8"	(Listed Below)	0.019	10'	25	500
AZF38ML	Aluminum 3/8"	Mill	0.019	10'	25	500
AZF44 - -	Aluminum 7/16"	(Listed Below)	0.019	10'	25	500
AZF44ML	Aluminum 7/16"	Mill	0.019	10'	25	500
AZF50 - -	Aluminum 1/2"	(Listed Below)	0.019	10'	25	500
AZF50ML	Aluminum 1/2"	Mill	0.019	10'	25	500
AZF62 - -	Aluminum 5/8"	(Listed Below)	0.019	10'	25	500
AZF62ML	Aluminum 5/8"	Mill	0.019	10'	25	500
AZF75 - -	Aluminum 3/4"	(Listed Below)	0.019	10'	25	500
AZF75ML	Aluminum 3/4"	Mill	0.019	10'	25	500
<hr/>						
GZF38 - -	Galvanized 3/8"	BK/RB/TB/WH	0.011	10'	25	500
GZF38ML	Galvanized 3/8"	Mill	0.013	10'	25	500
GZF44ML	Galvanized 7/16"	Mill	0.013	10'	25	500
GZF50 - -	Galvanized 1/2"	BK/RB/TB/WH	0.011	10'	25	500
GZF50ML	Galvanized 1/2"	Mill	0.013	10'	25	500
GZF62 - -	Galvanized 5/8"	BK/RB/TB/WH	0.011	10'	25	500
GZF62ML	Galvanized 5/8"	Mill	0.013	10'	25	500
GZF75 - -	Galvanized 3/4"	BK/RB/TB/WH	0.011	10'	25	500
GZF75ML	Galvanized 3/4"	Mill	0.013	10'	25	500

Siding Accessory Colors / • = ACM Color-Thru System™

COLOR	CODE	COLOR	CODE	COLOR	CODE	COLOR	CODE	COLOR	CODE
• ALMOND	AL	• CAMEO	CA	• EVERGREEN	EG	• PEBBLESTONE CLAY	PC	• VICTORIAN GREY	VG
• ANTIQUE IVORY	AI	• CHARCOAL GREY	CG	• HARBOR GREY	HG	• REDWOOD	RW	• VILLAGE GREEN	VI
• BEAVER BROWN	BB	• CLASSIC CREAM	CC	• HAZEL WOOD	XHW	• ROYAL BROWN	RB	• VINTAGE BRICK	XVB
• BLACK	BK	• CLAY	CL	• LAKESHORE FERN	XLF	• SAGE	SA	• WHITE	WH
• BONE WHITE	BW	• COLONIAL GRAY	CO	• LINEN	LI	• SANDTONE	ST	• WICKER	WI
• BRONZE	BZ	• COUNTRY BLUE	CU	• MONTANA SUEDE	XMS	• SILVER GREY	SG		
• BROOKSTONE	BS	• DESERT SAND	DS	• MUSKET BROWN	MB	• SNOWMIST WHITE	SM		
• BUCKSKIN	BU	• EVEREST	EV	• NORWEGIAN WOOD	NW	• TERRA BRONZE	TB		

Drip Cap

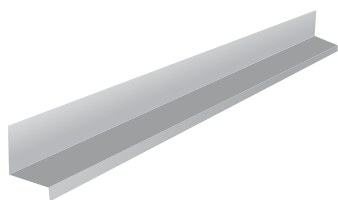

Part #	Description	Colors	Nom. Gauge/ Thickness	Piece Length	Pieces/ Box	Pieces/ Pallet
ADC078 - -	Aluminum 7/8" 90°	(Listed Below)	0.019	10'	25	1125
ADC078ML	Aluminum 7/8" 90°	Mill	0.019	10'	25	1125
ADC100 - -	Aluminum 1" 90°	(Listed Below)	0.019	10'	25	500
ADC100ML	Aluminum 1" 90°	Mill	0.019	10'	25	500
ADC118 - -	Aluminum 1-1/8" 90°	(Listed Below)	0.019	10'	25	500
ADC118ML	Aluminum 1-1/8" 90°	Mill	0.019	10'	25	500
ADC125 - -	Aluminum 1-1/4" 90°	(Listed Below)	0.019	10'	25	500
ADC125ML	Aluminum 1-1/4" 90°	Mill	0.019	10'	25	500
ADC138 - -	Aluminum 1-3/8" 90°	(Listed Below)	0.019	10'	25	500
ADC138ML	Aluminum 1-3/8" 90°	Mill	0.019	10'	25	500
ADC150 - -	Aluminum 1-1/2" 90°	(Listed Below)	0.019	10'	25	500
ADC150ML	Aluminum 1-1/2" 90°	Mill	0.019	10'	25	500
ADC158 - -	Aluminum 1-5/8" 90°	(Listed Below)	0.019	10'	25	500
ADC158ML	Aluminum 1-5/8" 90°	Mill	0.019	10'	25	500
ADC200 - -	Aluminum 2" 90°	(Listed Below)	0.019	10'	25	500
ADC200ML	Aluminum 2" 90°	Mill	0.019	10'	25	500

Drip Cap 90°

Part No.	"A"	ALUM "B"	GALV "B"
A/GDC078	7/8"	1-5/8"	1-5/8"
A/GDC100	1"	1-9/16"	1-9/16"
A/GDC118	1-1/8"	1-7/16"	1-7/16"
A/GDC125	1-1/4"	1-5/16"	1-5/16"
A/GDC138	1-3/8"	1-1/8"	1-1/8"
A/GDC150	1-1/2"	1-1/16"	1-1/16"
A/GDC158	1-5/8"	2-7/8"	2"
A/GDC175	1-3/4"	2-3/4"	1-7/8"
A/GDC200	2"	2-1/2"	1-5/8"

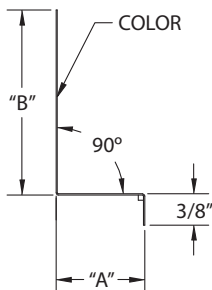

Drip Cap 95°

Part No.	"A"	"B"
A/GDC95118	1-1/8"	1-7/16"
A/GDC95125	1-1/4"	1-5/16"
A/GDC95200	2"	2-5/8"

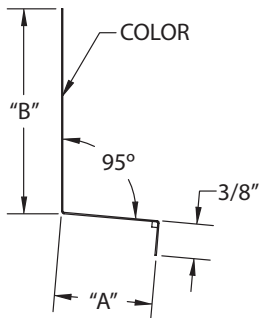

GDC078ML	Galvanized 7/8" 90°	Mill	0.013	10'	25	500
GDC100 - -	Galvanized 1" 90°	BK/RB/TB/WH	0.011	10'	25	500
GDC100ML	Galvanized 1" 90°	Mill	0.013	10'	25	500
GDC125ML	Galvanized 1-1/4" 90°	Mill	0.013	10'	25	500
GDC138 - -	Galvanized 1-3/8" 90°	BK/TB/WH	0.011	10'	25	500
GDC138ML	Galvanized 1-3/8" 90°	Mill	0.013	10'	25	500
GDC150 - -	Galvanized 1-1/2" 90°	BK/RB/TB/WH	0.011	10'	25	500
GDC150ML	Galvanized 1-1/2" 90°	Mill	0.013	10'	25	500
GDC158 - -	Galvanized 1-5/8" 90°	BK/RB/TB/WH	0.011	10'	25	500
GDC175ML	Galvanized 1-3/4" 90°	Mill	0.013	10'	25	500
GDC200 - -	Galvanized 2" 90°	BK/RB/TB	0.011	10'	25	500
GDC200ML	Galvanized 2" 90°	Mill	0.013	10'	25	500
ADC95118 - -	Aluminum 1-1/8" 95°	(Listed Below)	0.019	10'	25	500
ADC95118ML	Aluminum 1-1/8" 95°	Mill	0.019	10'	25	500
ADC95125 - -	Aluminum 1-1/4" 95°	(Listed Below)	0.019	10'	25	500
ADC95125ML	Aluminum 1-1/4" 95°	Mill	0.019	10'	25	500
ADC95200 - -	Aluminum 2" 95°	(Listed Below)	0.019	10'	25	500
ADC95200ML	Aluminum 2" 95°	Mill	0.019	10'	25	500
GDC95138ML	Galvanized 1-3/8" 95°	Mill	0.013	10'	25	500

Siding Accessory Colors / • = ACM Color-Thru System™

COLOR	CODE	COLOR	CODE	COLOR	CODE	COLOR	CODE	COLOR	CODE
• ALMOND	AL	• CAMEO	CA	• EVERGREEN	EG	• PEBBLESTONE CLAY	PC	• VICTORIAN GREY	VG
• ANTIQUE IVORY	AI	• CHARCOAL GREY	CG	• HARBOR GREY	HG	• REDWOOD	RW	• VILLAGE GREEN	VI
• BEAVER BROWN	BB	• CLASSIC CREAM	CC	• HAZEL WOOD	XHW	• ROYAL BROWN	RB	• VINTAGE BRICK	XVB
• BLACK	BK	• CLAY	CL	• LAKESHORE FERN	XLF	• SAGE	SA	• WHITE	WH
• BONE WHITE	BW	• COLONIAL GRAY	CO	• LINEN	LI	• SANDTONE	ST	• WICKER	WI
• BRONZE	BZ	• COUNTRY BLUE	CU	• MONTANA SUEDE	XMS	• SILVER GREY	SG		
• BROOKSTONE	BS	• DESERT SAND	DS	• MUSKET BROWN	MB	• SNOWMIST WHITE	SM		
• BUCKSKIN	BU	• EVEREST	EV	• NORWEGIAN WOOD	NW	• TERRA BRONZE	TB		

ROOFING *Accessories*



ACM is a “one stop shop” manufacturing system for all your exterior metal products.

ACM manufactures rainware, edge metals, trim coil, soffit and fascia, siding accessories, and metal roofing in aluminum, steel, and copper. We are constantly upgrading our plants and machinery to improve quality, add additional profiles, and create new innovative products.

Homeowners want consistent color matches for their soffit and fascia, rainware, edge metals, trim coil, and siding accessories.

Some contractors buy gutter coil, soffit and fascia, edge metals, etc., from a wide variety of manufacturers and supply centers to get the lowest cost. The end result is that their components don't quite match and now it's permanently spoiled the appearance of the home.

Our **Color-Thru System™** has 24 colors to which you can match all parts of the house. You can use this system of colors to help you sell more jobs. The homeowner will see more value in your proposal if you can provide accurate color matches on all parts of the house.

Aluminum is made with majority of post consumer waste.

Aluminum and steel are recyclable, aluminum even more so. Did you know that Aluminum can be recycled over and over again? 75% of all aluminum ever smelted is still being recycled.

We keep Green Circle Certificates on hand for your access proving that 75% more of our raw material comes from recycled consumer waste. You may use this information to advertise that you are a “Green” company or as back-up documentation for government projects.

For Customer Service: 877-279-5096



ROOFING *Accessories*

Beloit Plant Coverage Region

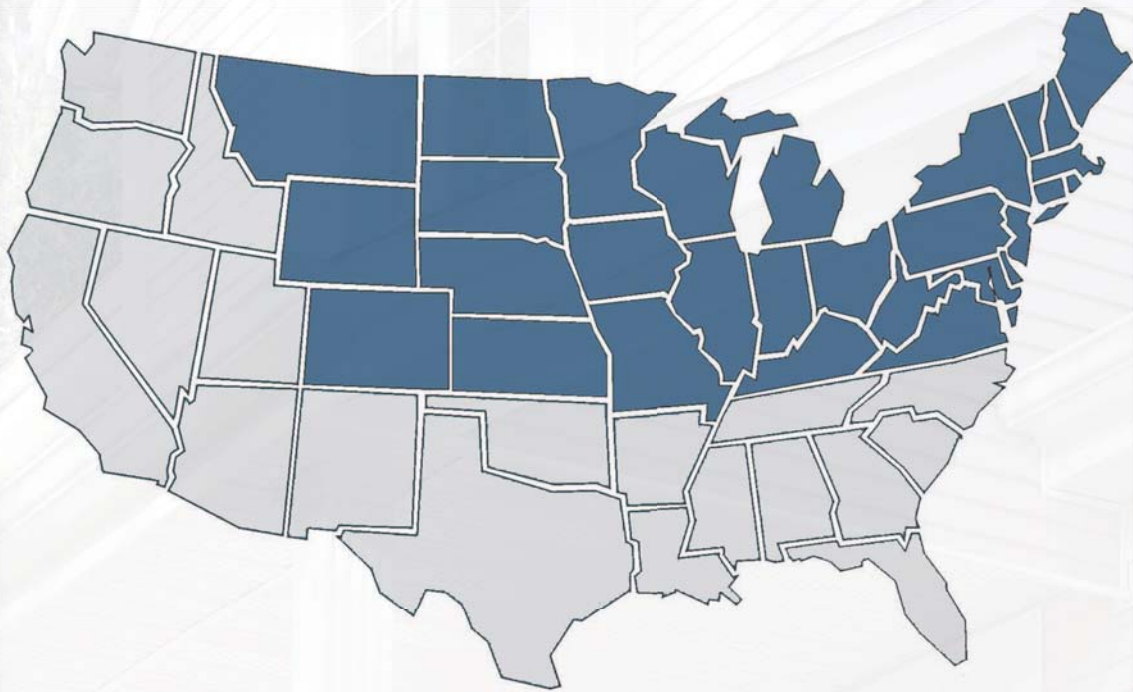

Customer Service: 877-279-5096
www.acm-metals.com